

ROHS Compliant

DATE	2023/10/20
Revision	B

Features :

- T-568A/B Dual wiring
- RJ45 complies with FCC part 68 standard
- 110/Krone dual IDC connector compatible
- Provides termination for 22~26 AWG wire
- Jack insertion life >750 mating cycles
- IDC insertion life >250 mating cycles
- Operating temperature : -40°C ~ +60°C

Electrical :

- Contact resistance : 20m ohm
- DC Current rating : 1.5Amps
- DC resistance : Max.0.1 ohm
- Insulation Resistance : 500m ohm
- Dielectric withstanding voltage : 1000V
- IDC terminals no solder

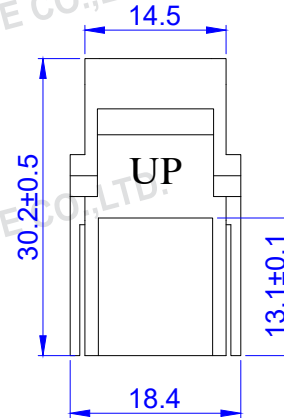
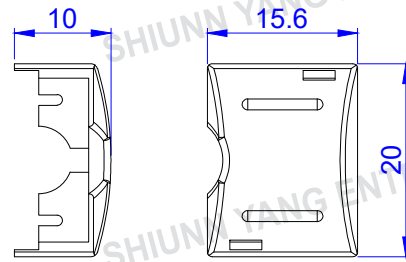
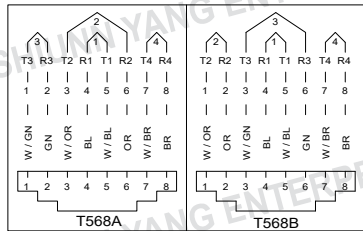
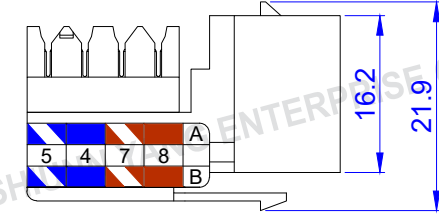
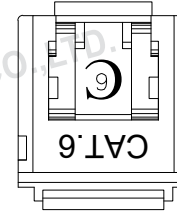
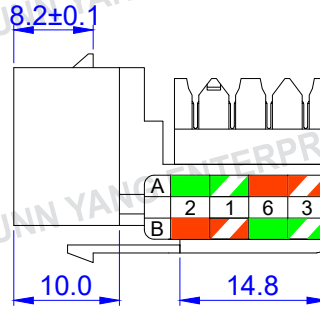
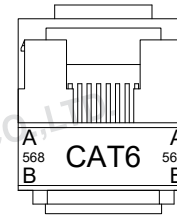

ENCLOSURE  
IDC CAP x 1 PC

TOLERANCE

.XXX	0.10
.XX	0.25
.X	0.38

MATERIAL

CATEGORY	<input type="checkbox"/> CAT.5E <input checked="" type="checkbox"/> CAT.6 <input type="checkbox"/> CAT.3 <input type="checkbox"/> OTHER _____
HOUSING	ABS UL94V-0
CONTACT	0.35 mm DIAMETER PHOSPHOR BRONZE GOLD PLATED OVER NICKEL
GOLD-PLATING	<input type="checkbox"/> 0.0762um/3u inch <input type="checkbox"/> 0.15um/6u inch <input type="checkbox"/> 0.38um/15u inch <input type="checkbox"/> 0.76um/30u inch <input checked="" type="checkbox"/> 1.27um/50u inch
COLOR	<input type="checkbox"/> WHITE <input type="checkbox"/> BLACK <input type="checkbox"/> GREEN <input type="checkbox"/> BLUE <input type="checkbox"/> YELLOW <input type="checkbox"/> RED <input type="checkbox"/> ORANGE <input type="checkbox"/> IVORY <input type="checkbox"/> OTHER _____
TYPE OF PRODUCT	<input checked="" type="checkbox"/> UNSHIELD <input type="checkbox"/> SHIELD : 0.25mm THICKNESS COPPER ALLOY WITH NICKLE PLATED.

P/NO. SY-504-8C-PXX

ITEM. Keystone Jack	CO. SY	S/N. SY-504-8C-PXX
DR.	APPD. Sweet 2023/10/20	CHKD.



Shiunn Yang Ent.Co.Ltd.  
TEL: 29089890 <REP>  
FAX: 29068849,29088679

FILE. SY-504-8C-PXX

SCALE /	
UNIT mm	SIZE A4

REV.	DESCRIPTION	ENG.	APPROVAL
------	-------------	------	----------