

Date	2005/03/24
Revision	A

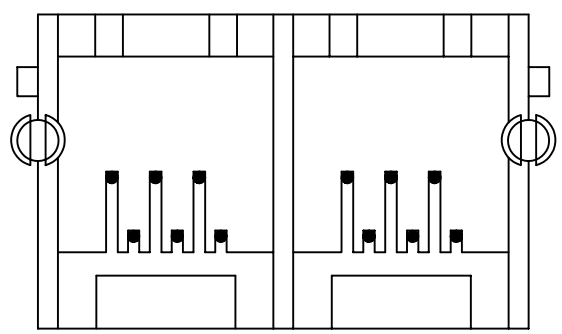
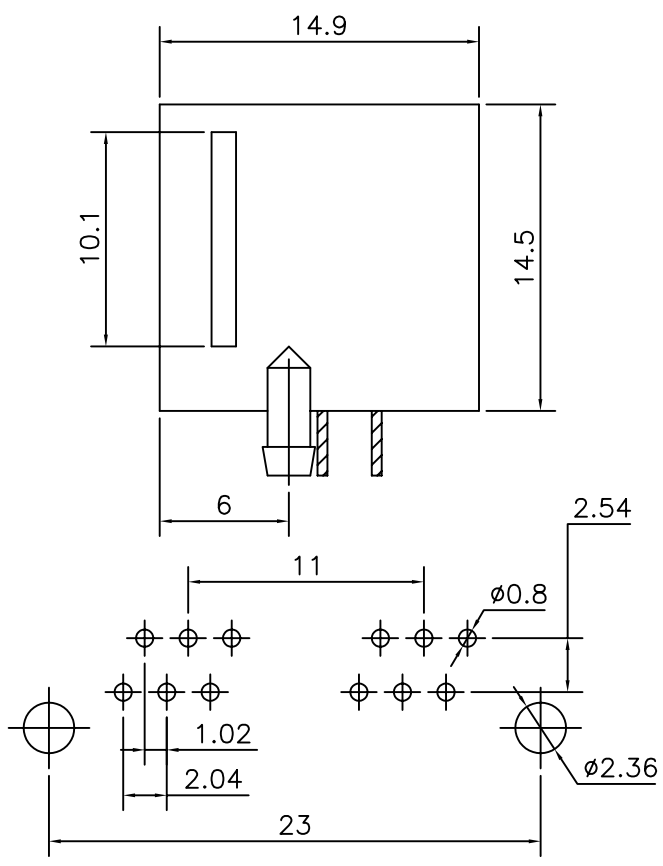
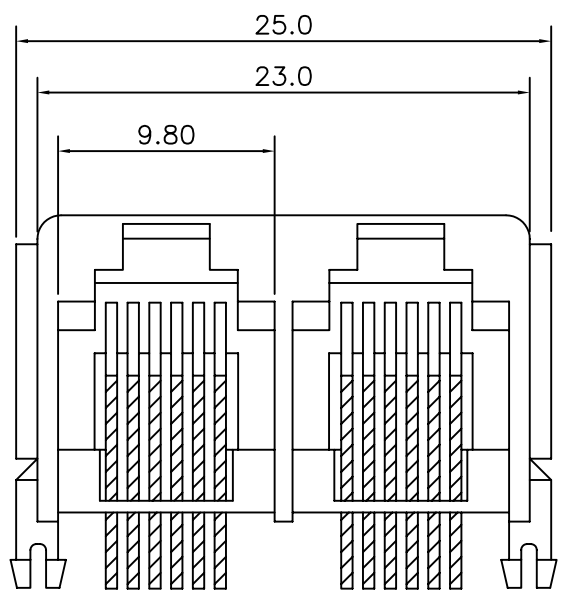

TOLERANCE	
.XXXX	----
.XXX	0.10
.XX	0.25
.X	0.38

P/NO. SY002-3-6

TECHNICAL DATA			
HOUSING	STANDARD MATERIAL 15% GLASS FILLED PBT UL94V-0	COLOR	GRAY, BLACK
CONTACT	0.46 DIAMETER PHOSPHOR BRONZE GOLD PLATED OVER NICKEL		
GOLD-PLATING	<input type="checkbox"/> 0.0762 um / 3u inch <input type="checkbox"/> 0.15 um / 6u inch <input type="checkbox"/> 0.38 um / 15u inch <input type="checkbox"/> 0.76 um / 30u inch		
	<input type="checkbox"/> 1.27 um / 50u inch		
REV.	DESCRIPTION	ENG.	APPROVAL

ITEM MODULAR PCB JACK	CO. SY	FILE SY002-3-6
DR. Hansum2005/03/24	APPD.	CHKD.



Shiunn Yang Ent.Co.Ltd.
TEL: 29089890 <REP>
FAX: 29068849,29088679

SCALE /	
UNIT mm	SIZE A4
SHEET	REV.