

Date	2005/03/25
Revision	A

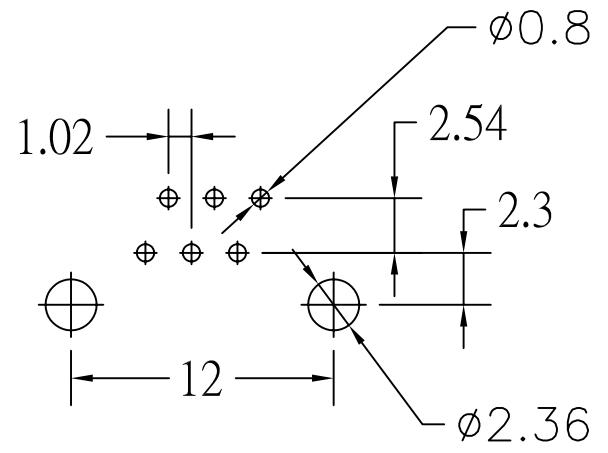
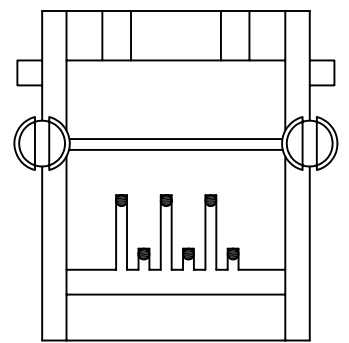
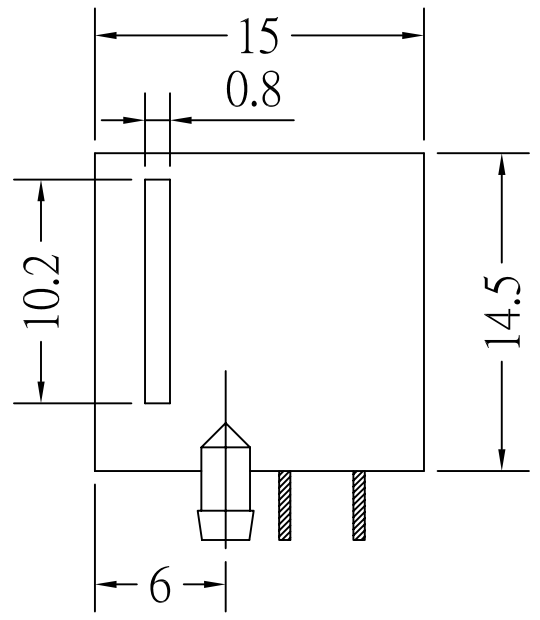
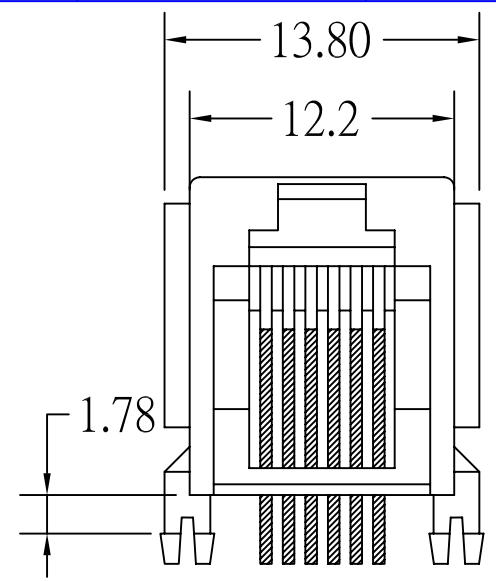

TOLERANCE	
.XXXX	----
.XXX	0.10
.XX	0.25
.X	0.38

P/NO. SY010-6

TECHNICAL DATA			
HOUSING	STANDARD MATERIAL 15% GLASS FILLED PBT UL94V-0	COLOR	GRAY,BLACK
CONTACT	0.46 DIAMETER PHOSPHOR BRONZE GOLD PLATED OVER NICKEL		
GOLD-PLATING	<input type="checkbox"/> 0.0762 um / 3u inch <input type="checkbox"/> 0.15 um / 6u inch <input type="checkbox"/> 0.38 um / 15u inch <input type="checkbox"/> 0.76 um / 30u inch		
	<input type="checkbox"/> 1.27 um / 50u inch		
REV.	DESCRIPTION	ENG.	APPROVAL

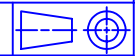
ITEM MODULAR PCB JACK	CO. SY	FILE SY010-6
DR. Hansum2005/03/25	APPD.	CHKD.
 Shiunn Yang Ent.Co.Ltd. TEL: 29089890 <REP> FAX: 29068849,29088679	SCALE /	
	UNIT mm	SIZE A4
	SHEET	REV.