

Date	2005/08/09
Revision	A

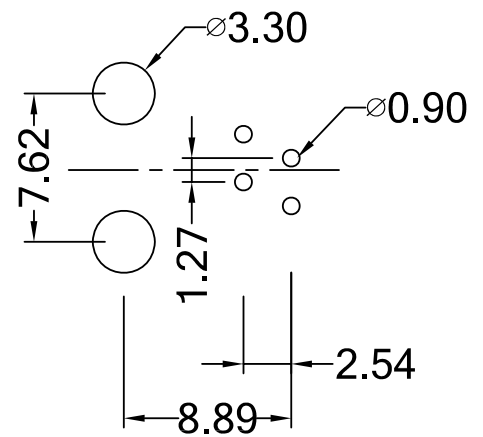

PCB LAYOUT / TOP VIEW

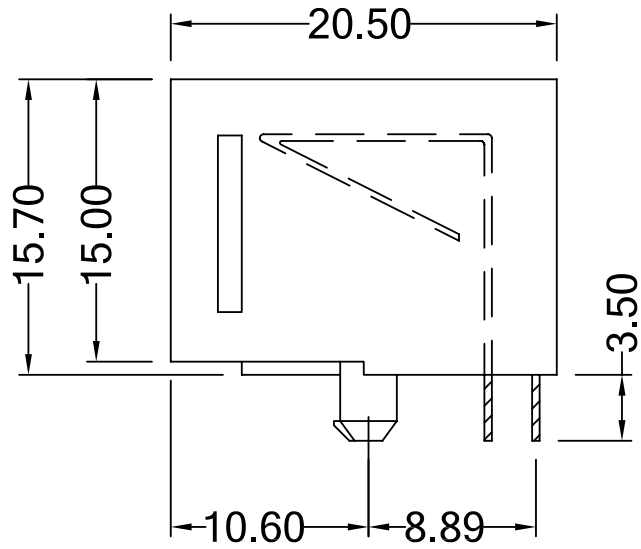
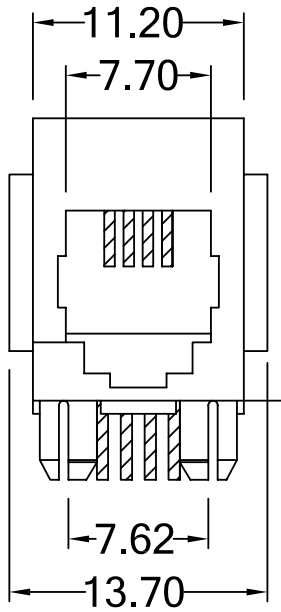
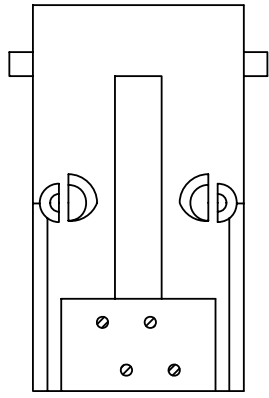

TOLERANCE	
.XXXX	---
.XXX	0.10
.XX	0.25
.X	0.38

P/NO. SY025-4

TECHNICAL DATA				ITEM MODULAR PCB JACK	CO. SY	FILE SY025-4
HOUSING	STANDARD MATERIAL 15% GLASS FILLED PBT UL94V-0	COLOR	GRAY, BLACK	DR. Hansum2005/08/09	APPD.	CHKD.
CONTACT	0.35 DIAMETER PHOSPHOR BRONZE GOLD PLATED OVER NICKEL					
GOLD-PLATING	<input type="checkbox"/> 0.0762 um / 3u inch <input type="checkbox"/> 0.15 um / 6u inch <input type="checkbox"/> 0.38 um / 15u inch <input type="checkbox"/> 0.76 um / 30u inch <input type="checkbox"/> 1.27 um / 50u inch			 Shiunn Yang Ent.Co.Ltd. TEL: 29089890 <REP> FAX: 29068849,29088679		
REV.	DESCRIPTION	ENG.	APPROVAL	SCALE /	UNIT mm	SIZE A4
				SHEET		REV.